

TENONTEQ

D-500 / 600 / 800

Speed and precision for floor production

Double-End Tenoners for floor production





A Solution for Every Task: Laminate, Parquet, LVT and SPC – a Variety of Top Quality Products

Products to suit every taste. The HOMAG plant range offers almost unlimited processing scope for a wide range of materials. In a variety of dimensions and forms: whether it is cork flooring elements, linoleum or veneered surfaces, laminate flooring in wood or tile designs or even SPC and LVT flooring. The plant range from HOMAG gives you the product variety you need to meet all market requirements.

YOUR SOLUTION

[MORE AT HOMAG.COM](https://www.homag.com)



Content

- 04 Highlights
- 06 Plant Concepts
- 08 Standard Equipment of HOMAG Double-End Tenoners
- 12 Transport Systems Used in Our Machines
- 13 The Key Features of Our Models
- 16 TENONTEQ D-500 profiLine
- 18 TENONTEQ D-600 profiLine
- 20 TENONTEQ D-800 powerLine
- 22 Life Cycle Services

Hightlights

As a technology leader, HOMAG carries out groundbreaking work, providing you with numerous, highly innovative new developments. You will receive tailor-made solutions, enabling you to carry out flexible mass production of individual products. Alongside a variety of decorative elements and wood types, surface properties and formats, HOMAG plants can be enhanced with extensions such as footfall sound applications, chamfer lacquering and, last but not least, product packaging to suit customer requirements.

We provide systematic process reliability – efficient, durable and profitable. Our many years of global experience in planning and implementing plants ensure the highest quality standards and a smooth processing flow. We coordinate with partners based on project requirements – and always with the aim of providing maximum customer benefit.

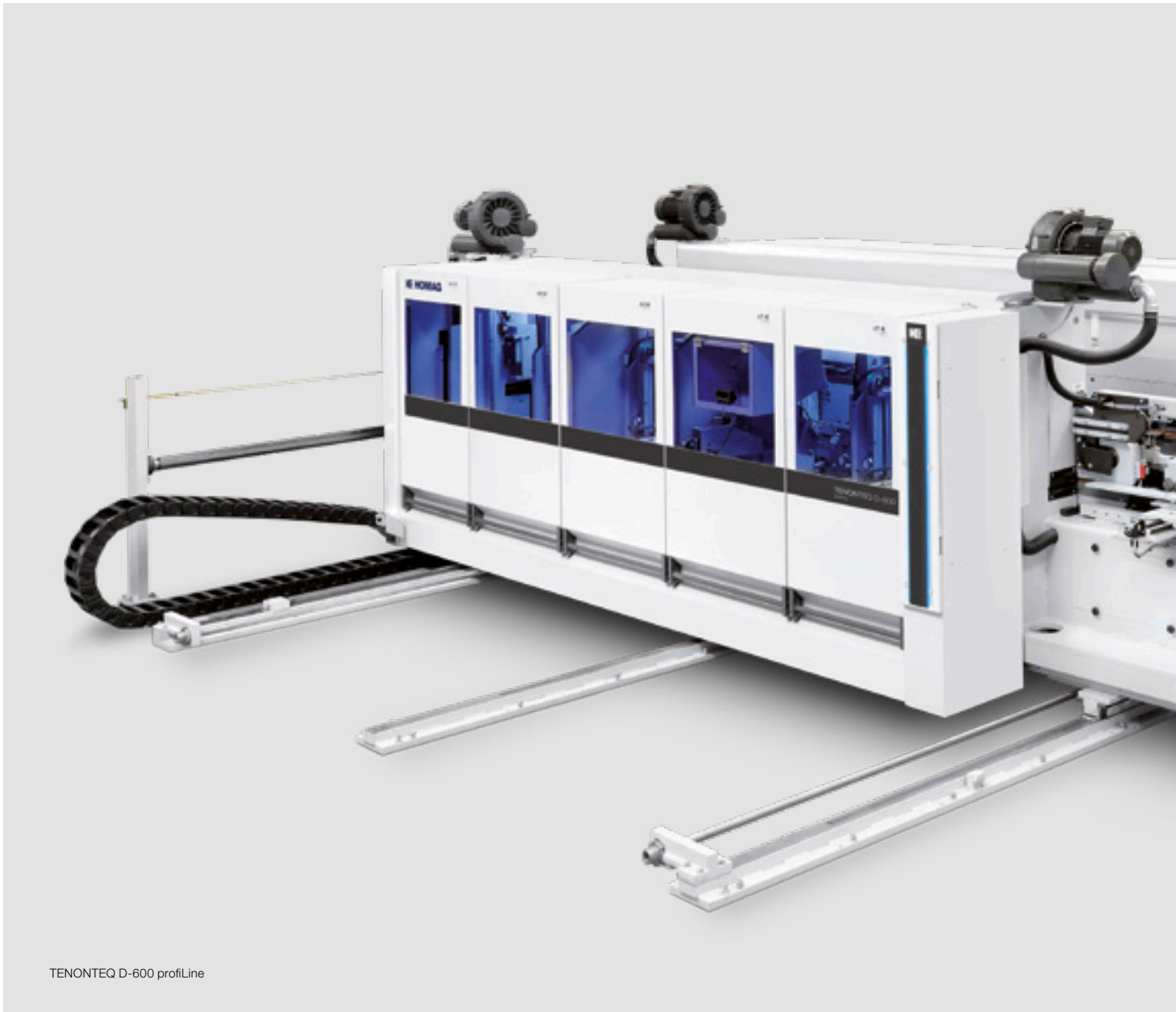

TENONTEQ D-600 profiLine

YOUR BENEFITS

- Substantial range of plants
- From the entry-level machine to the complete production line
- Over 1,000 production lines supplied worldwide
- Process wide-ranging materials with maximum precision



Plant Concepts

We create plant concepts according to the needs of our customers. Plants can be freely constructed to suit the task at hand and the available space. No matter whether it is a new plant or an extension, we pour all the experience and

knowledge gained on over 1,000 flooring plants worldwide into planning your plant – to give you a competitive edge.

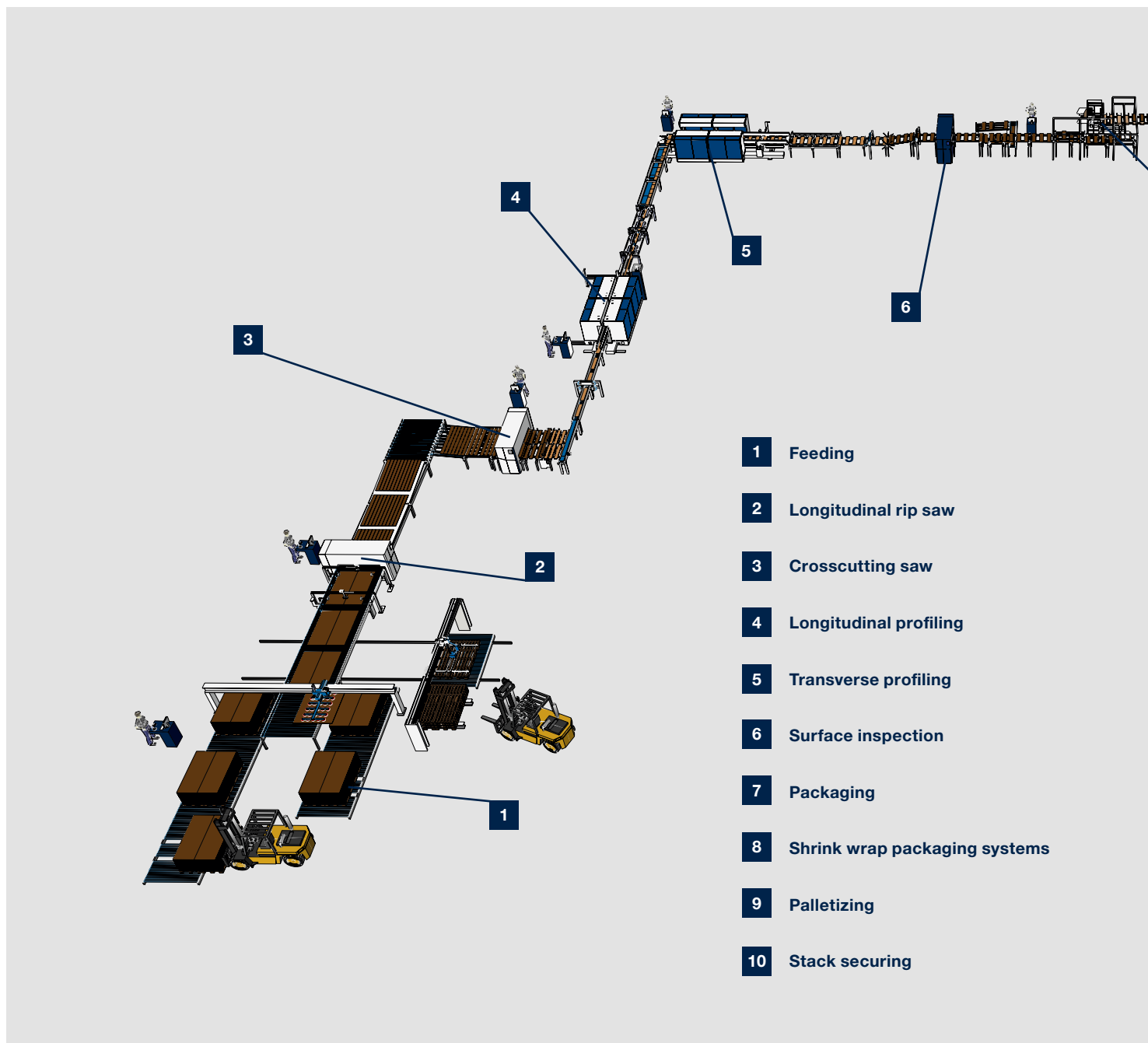



Standard Equipment of HOMAG Double-End Tenoners

The double-sided HOMAG sizing machines from the TENONTEQ D-500, TENONTEQ D-600 und TENONTEQ D-800 series offer excellent processing quality in a cost-effective solution that is guaranteed to impress. In all

performance categories, they are characterized by high-quality components which are already included as standard equipment. This means you can produce your flooring elements with maximum profile accuracy.

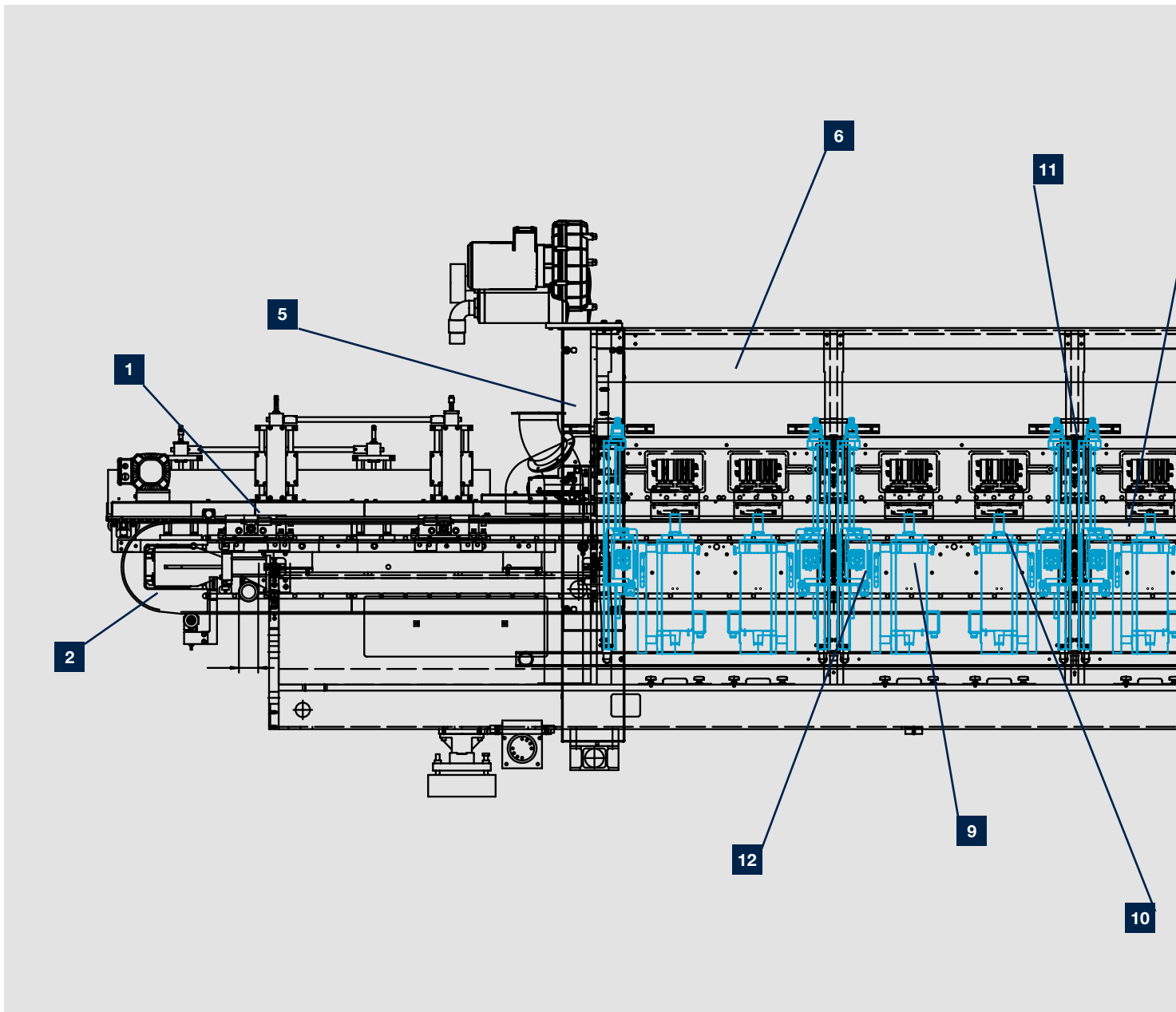



Tension-free infeed system for smooth workpiece supply



The rolling chain also ensures quiet running, even at high feed rates



Frequency or servo-controlled drive systems ensure a steady feed rate at all speeds with TENONTEQ D-600 (optional transverse processing)

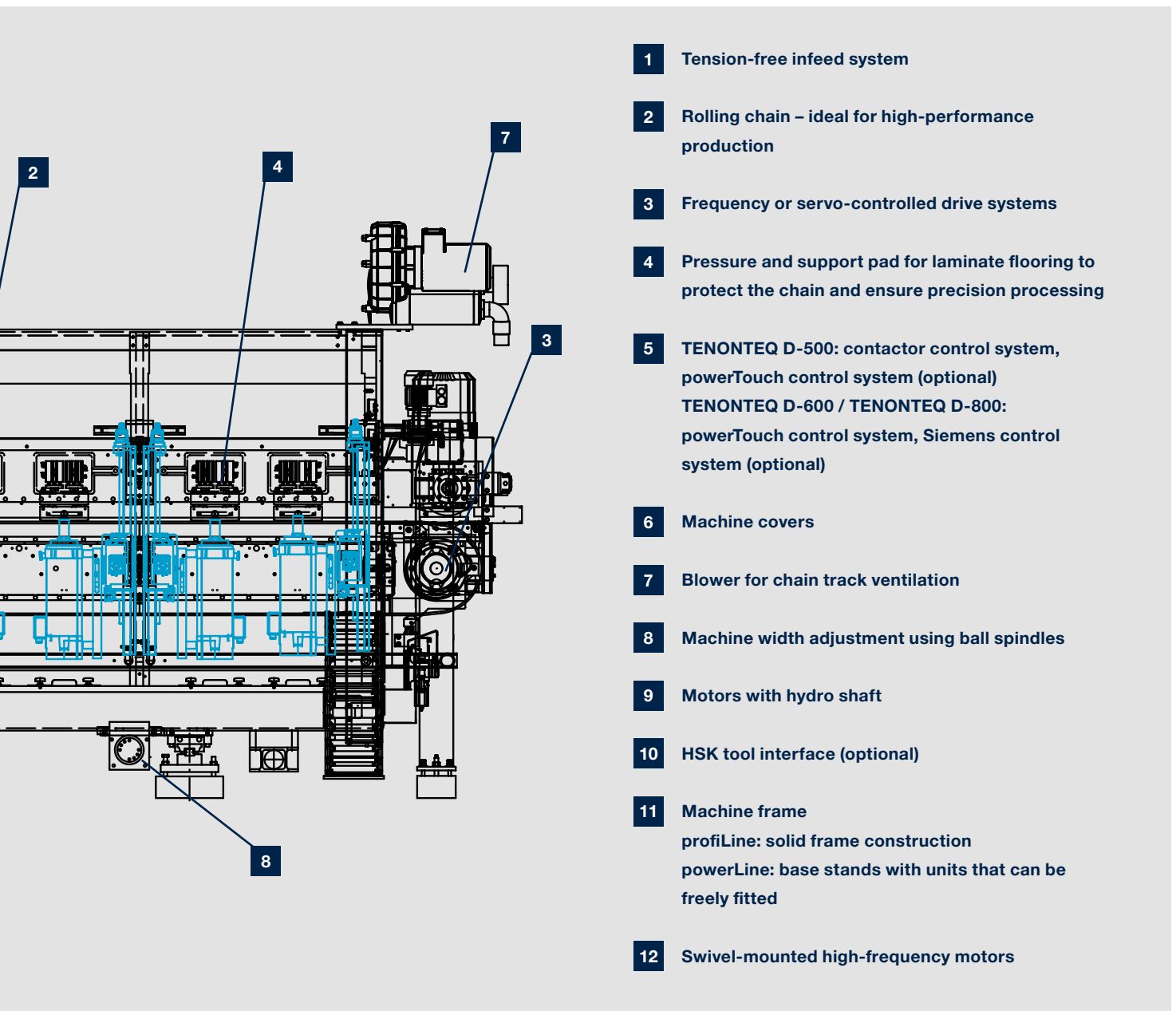

- 1** Tension-free infeed system
- 2** Rolling chain – ideal for high-performance production
- 3** Frequency or servo-controlled drive systems
- 4** Pressure and support pad for laminate flooring to protect the chain and ensure precision processing
- 5** TENONTEQ D-500: contactor control system, powerTouch control system (optional)
TENONTEQ D-600 / TENONTEQ D-800: powerTouch control system, Siemens control system (optional)
- 6** Machine covers
- 7** Blower for chain track ventilation
- 8** Machine width adjustment using ball spindles
- 9** Motors with hydro shaft
- 10** HSK tool interface (optional)
- 11** Machine frame
profiLine: solid frame construction
powerLine: base stands with units that can be freely fitted
- 12** Swivel-mounted high-frequency motors

Further Standard Equipment Components

The robust framework structure, precision trimming units, machine width adjustment using ball spindles as well as the various machine control options are just a few of the

elements which provide you with a sound basis for your profiling tasks.



Pressure and support pad for laminate flooring to protect the chain and ensure precision processing. Additional support is provided for the workpiece in the area of the processing unit.



Control systems
TENONTEQ D-500: contactor control system, powerTouch control system (optional)
TENONTEQ D-600 / TENONTEQ D-800: powerTouch control system, Siemens control system (optional)

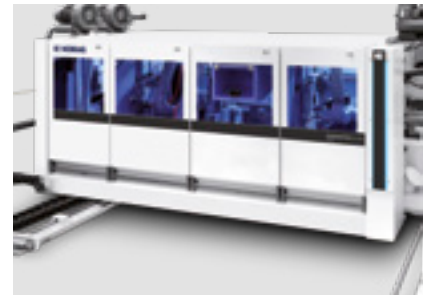

Machine casing for reducing noise emissions



Blower for chain track ventilation to prevent accumulation of dust in the chain guide rail



Machine width adjustment using ball spindles ensures excellent positioning accuracy and low wear



Motors with hydro shaft for the ultimate in concentricity

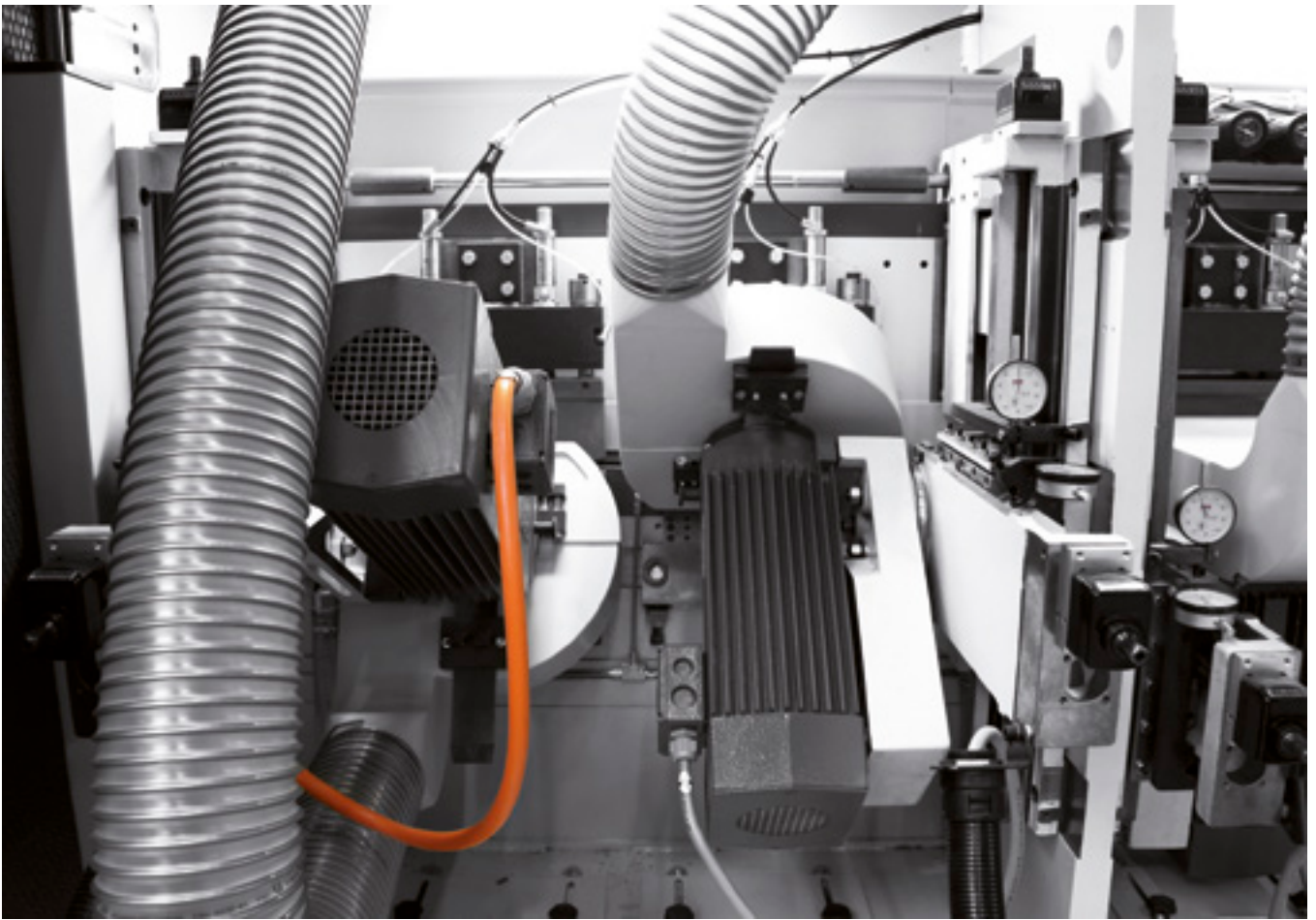

Swivel-mounted high-frequency motors enable complex profiles to be processed



HSK tool interface (optional) for quick and easy tool change with high changeover accuracy.



Machine frame
 profiLine: solid frame construction
 powerLine: base stands with units that can be freely fitted

Transport Systems Used in Our Machines

We offer a range of different transport systems to suit requirements and part dimensions: various chain-mounted systems, the patented Magnetic Chain System (MCS) for speeds > 100 m/min and chain plates adapted to meet

requirements. These create a perfectly coordinated solution for profiling your flooring elements – whether wide or narrow, laminate, parquet, LVT or SPC.

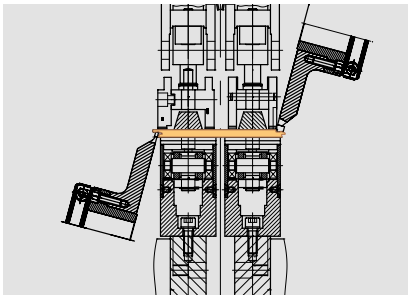

Parquet/LVT – double standard chain

- Integrated dual pressure pads
- High-precision chain
- Powered top pressure belt

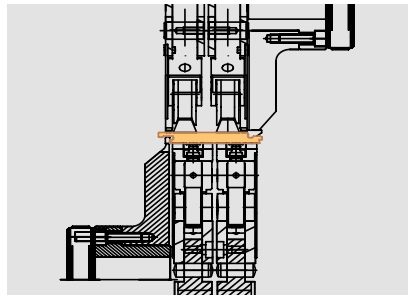

Parquet/LVT – narrow chain

- Integrated pressure pads
- High-precision chain
- Powered top pressure belt

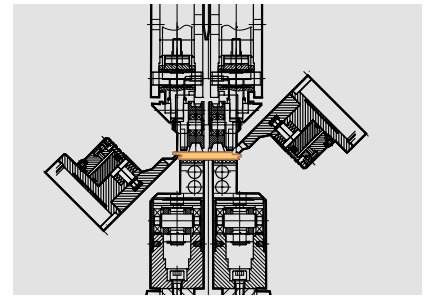

Parquet/LVT – narrow chain W1

- Pneumatic rollers in the top pressure belt
- High-precision chain
- Powered top pressure belt

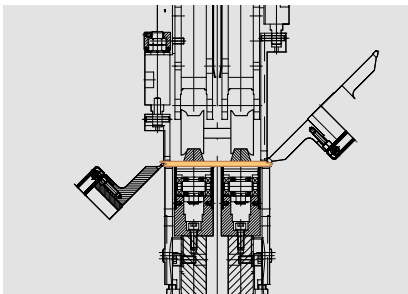

Laminate/SPC – double standard chain

- External pressure pads
- External support rails
- Powered top pressure belt

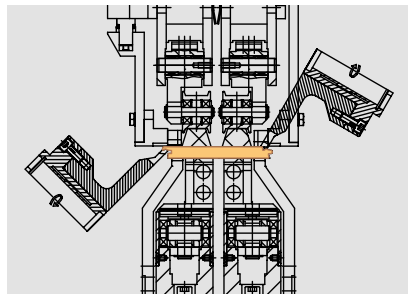

Laminate/SPC – narrow chain W2

- External pressure pads
- External support rails
- Powered top pressure belt

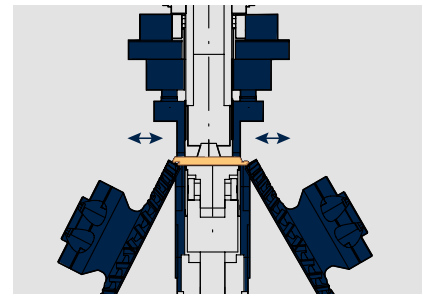

Laminate/SPC – single standard chain

- External adjustable pressure pads
- External adjustable support rails
- Powered top pressure belt
- Synchronous operation of format stands and pressure pads

Double-End Tenoners for Floor Production – The Key Features of Our Models

Our three series TENONTEQ D-500, D-600 und D-800 cover the entire range of floor profiling requirements. The choice is yours: maximum feed rate of 100 – 300 m/min, up to 10 units

can be fitted, or more on request, contactor control system, powerTouch or Siemens controller. All series feature the proven, precision rolling block link chain.



TENONTEQ D-500 profiLine – entry-level machine with low-vibration design

- Feed rates of up to 100 m/min
- Solid framework structure for max. 8 processing units
- Rolling block link chain
- Proven contactor control system, optional powerTouch

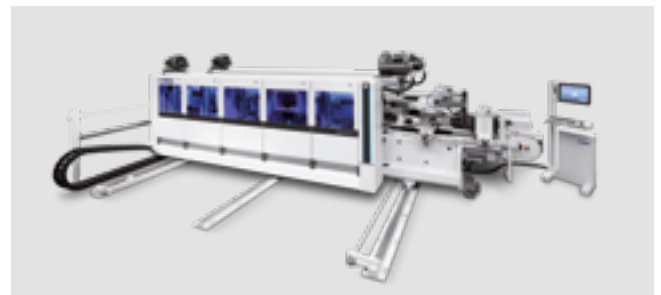

TENONTEQ D-600 profiLine – a cost-effective solution that meets all your needs

- Feed rate of up to 130 m/min with patented magnetic chain
- Optional horizontally adjustable top pressure belt
- Optional machine extension for edge coating
- powerTouch control system, Siemens optional

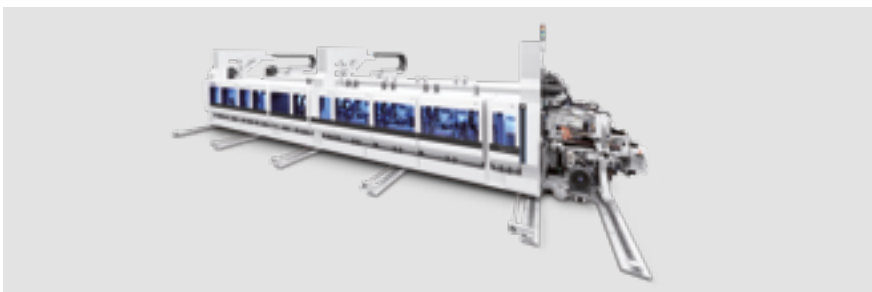

TENONTEQ D-800 powerLine – for the ultimate in flexibility and performance

- Feed rates of up to 300 m/min
- Optional horizontally adjustable top pressure belt
- Magnetic chain for a long service life, high feed speed and low running costs (longitudinal processing)
- powerTouch control system, Siemens optional
- Individual machine configuration

TENONTEQ D-600 profiLine

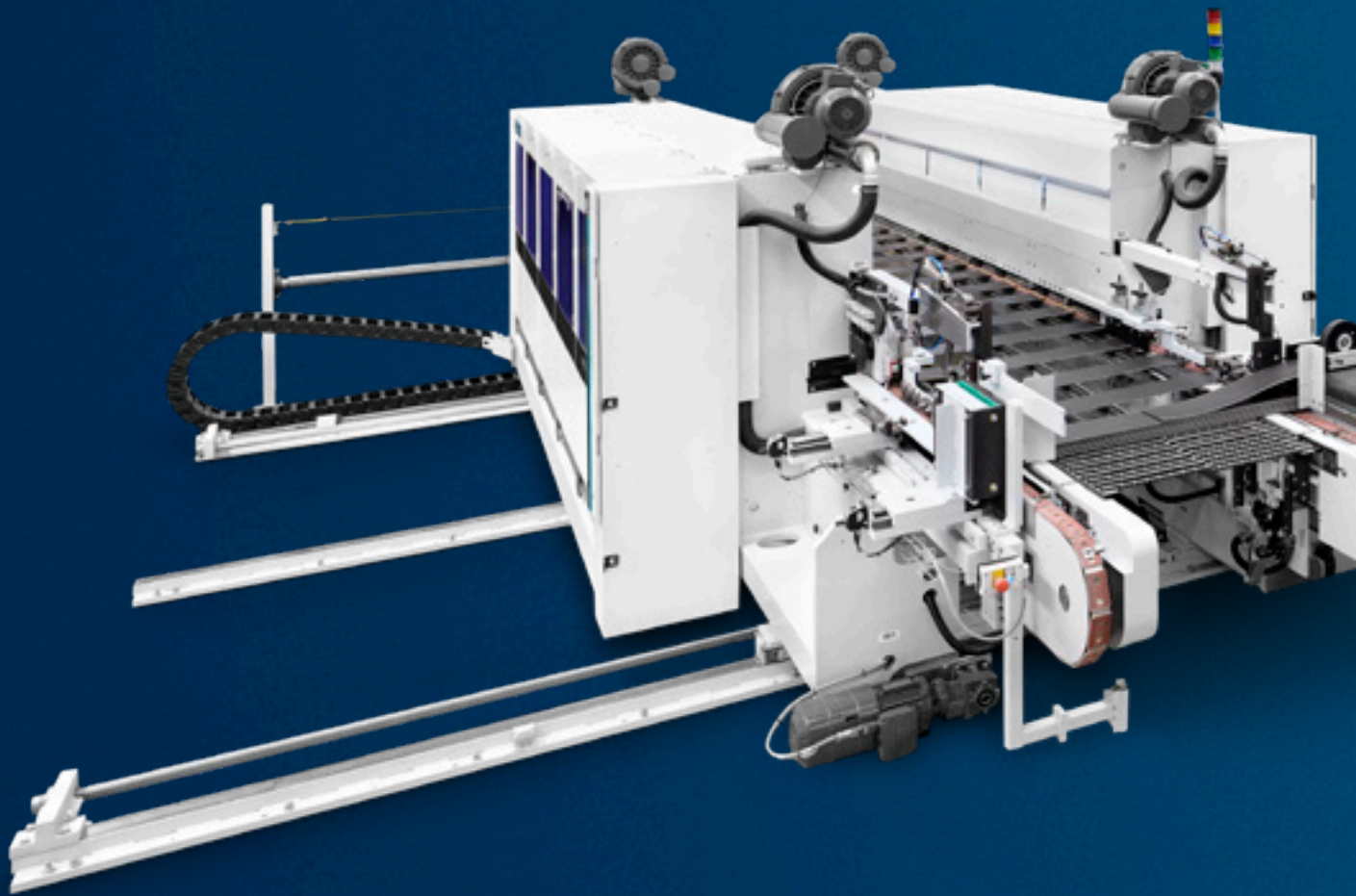



TENONTEQ D-500 profiLine

The compact double-sided sizing machines offer excellent processing quality in a cost-effective solution that is guaranteed to impress. Our entry-level range offers quiet running through a high machine weight, precise swivel-mounted high-frequency motors as well as a freestanding

switch cabinet with cooling unit as a matter of course. Machines from the TENONTEQ D-500 series are characterized by high manufacturing precision for tongue and groove and Click and Loc profiles.



Tension-free infeed system with improved stability

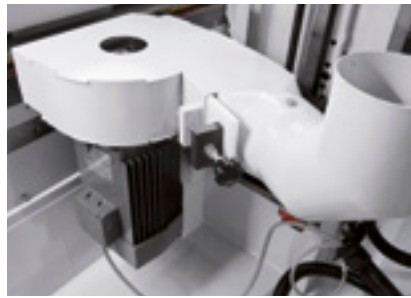

Each motor has a dust hood adjusted to suit the tool

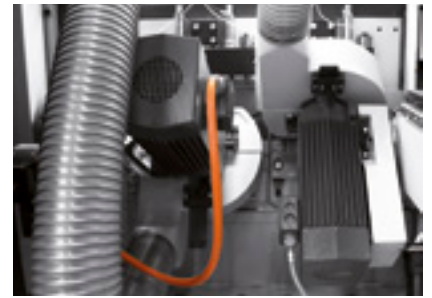

Swivel-mounted high-frequency motors with individual extraction system



Intermediate magazine especially for LVT



Chain track ventilation on both sides



Freestanding switch cabinet with cooling unit and separate frequency converter per motor

Technical Data

	Parquet / LVT / WPC / SPC			Laminate		
	Double standard chain	Narrow chain with pressure pad	Narrow chain W1	Double standard chain	Narrow chain N	Narrow chain
Speed, longitudinal (m/min)	max. 100	max. 100	max. 100	max. 100	max. 100	max. 100
Speed, transverse (m/min)	max. 45	–	–	max. 45	–	–
Number of motors	max. 8	max. 8	max. 8	max. 8	max. 8	max. 8
Workpiece thickness (mm)	4 – 25	4 – 25	4 – 25	6 – 15	6 – 15	6 – 15
Workpiece length (mm)	400 – 2,500	400 – 2,500	400 – 2,500	600 – 2,500	600 – 2,500	600 – 2,500
Workpiece width (mm)	138 – 250 (620*)	75 – 250	57 – 250	180 – 400	100 – 250	120 – 250
Motor setting angle	-90° – +90°	-90° – +90°	-90° – -45° +90° – +45°	-90° – 0° – +90°	-90° – 0° – +90°	-90° – 0° – +90°

*option



TENONTEQ D-600 profiLine

The new TENONTEQ D-600 series covers all flooring production applications. Thanks to the modular design, the machines are more rigid and stable and offer flexible solutions for longitudinal and transverse profiling of a wide

range of materials. This means you can achieve maximum profile accuracy on any profile type with our precision manufacturing systems.



Magnetic chain



Optional horizontally adjustable top pressure belt



Optional extension for the application of edge sealing



Supporting room extraction



Unit guidance systems with high-precision setting device and swivel-mounted high-frequency motors



Easy-to-use powerTouch control system. Remote troubleshooting diagnostics service available

Technical Data

	Parquet / LVT / WPC			Laminate / SPC	
	Double standard chain	Narrow chain W1	Narrow chain W2 with pressure pad	Double standard chain	Narrow chain W2
Speed, longitudinal (m/min)	max. 100/130*	max. 100/130*	max. 100/130*	max. 130	max. 130
Speed, transverse (m/min)	max. 40/60*	–	–	max. 60	max. 60
Number of motors	max. 12	max. 12	max. 12	max. 12	max. 12
Workpiece thickness (mm)	4 – 25	4 – 25	4 – 25	6 – 15	6 – 15
Workpiece length (mm)	400 – 2,500	400 – 2,500	400 – 2,500	600 – 1,500	600 – 1,500
Workpiece width (mm)	138 – 250 (620*)	57 – 250	75 – 250	175 – 400	123 – 250
Motor setting angle	-90° – +90°	-90° – -45° +90° – +45°	-90° – -30° +90° – +30°	-90° – 0° – +90°	-90° – 0° – +90°

*option

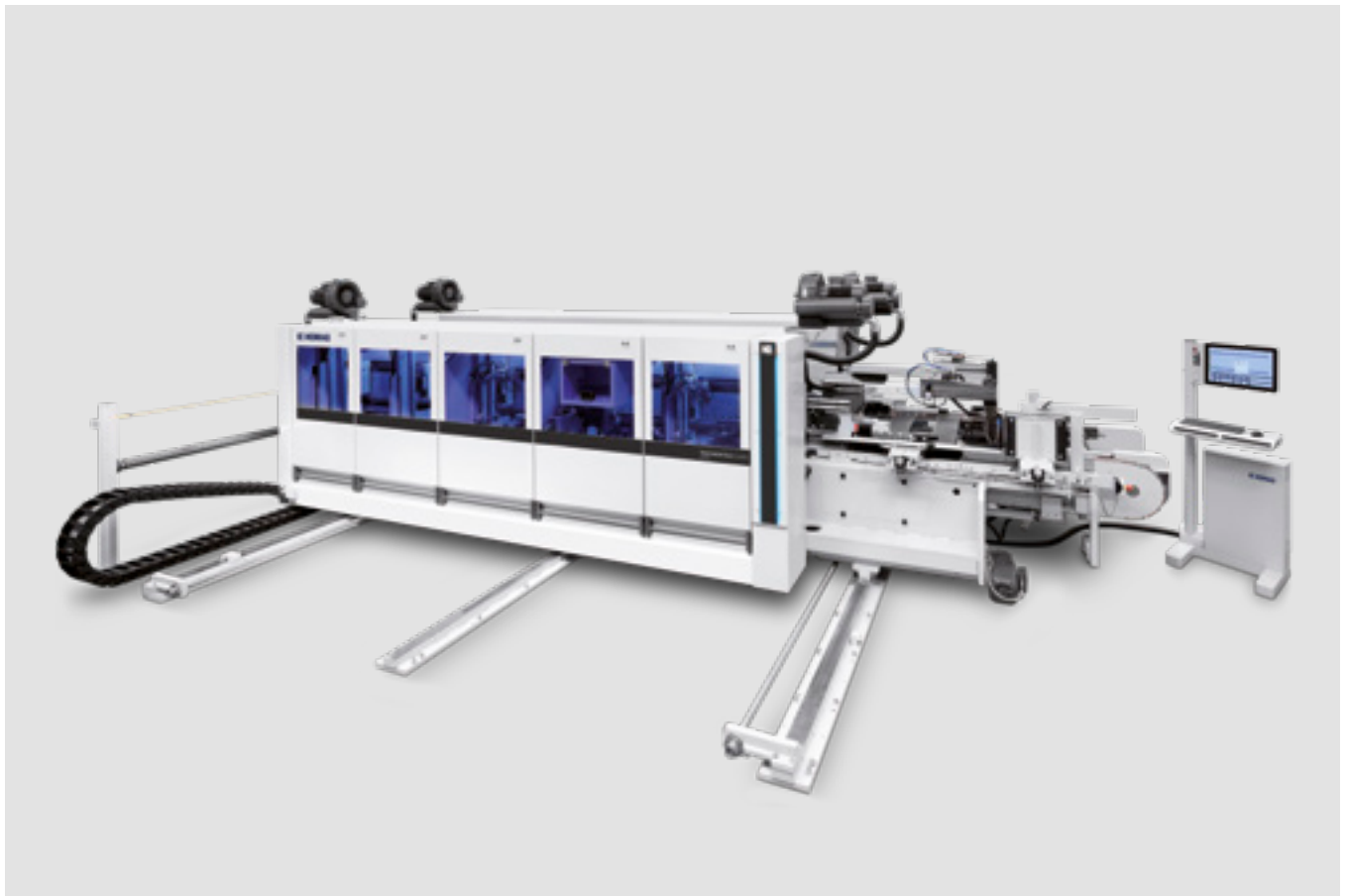

TENONTEQ D-800 powerLine

With flexibly positionable supports on the trimming motors, this series is our high-end solution – for maximum output whatever the batch size. It ticks all the boxes when it comes to performance and flexibility. We configure these double-

sided machines to suit your needs – including the required number of motors. We offer a machine extension option for setting up an edge sealing or chamfer lacquering system.

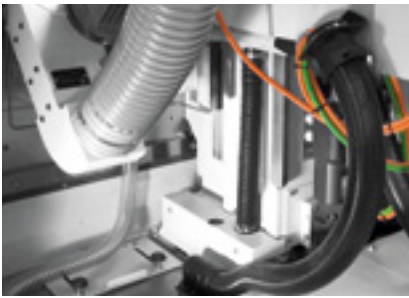

Servo-positionable format stands



Workpiece magazine for high cycle-performance



Digital display with setpoint selection for precise and easy adjustment



Optional extension for the application of edge sealing or chamfer lacquering



Supporting room extraction



High-power trimming unit SF30 with automatic adjustments

Technical Data

	Parkett / WPC		Laminat / SPC	
	Double Standard chain	Narrow chain W3	Double Standard chain	Narrow chain W3
Speed, longitudinal (m/min)	max. 250	max. 200	max. 300	max. 200
Speed, transverse (m/min)	max. 40 – 80	–	max. 45 (80°)	–
Number of motors	Can be freely fitted up to a max. length of 18	Can be freely fitted up to a max. length of 18	Can be freely fitted up to a max. length of 18	Can be freely fitted up to a max. length of 18
Workpiece thickness (mm)	4 – 25	4 – 25	6 – 15	6 – 15
Workpiece length (mm)	400 – 2,500	400 – 2,500	600 – 2,500	600 – 2,500
Workpiece width (mm)	138 – 400	125 – 300	185 – 400	123 – 400
Motor setting angle	-90° – +90°	-90° – -30° +90° – +30°	-90° – 0° – +90°	-90° – -30° +90° – +30°



VALYOU

Our Mission, Your Performance.

LIFE CYCLE SERVICES

Improved performance, more efficient processes, faster help, assurance of availability and smarter working

TEAM & COVERAGE

Largest global service network in the industry with over 1,350 personnel.

INSTALLATION & COMMISSIONING

For a smooth start, we only let proven experts manage your setup.

OPERATION & CONTROL

After teaching your personnel the intuitive control system, our clever apps help to make the operator's life much easier.

MAINTENANCE & SERVICING

To keep things running, we're happy to take a preventative approach. You decide how often and how intensively you want the support to be. As we all know, prevention is better than the cure.

eSHOP & ONLINE ADVANTAGE

A few clicks and it's fixed. Receive exclusive advantages by ordering spare parts online, depending on market availability. shop.homag.com

HOTLINE & READINESS

When there's an emergency, we're here. Direct by phone, digitally via app or video, or with on-site support. We are close to you with over 90 regional service organizations worldwide. With more than 35,000 spare parts immediately available, we can deliver 85% of your orders fast.

TRAINING & EDUCATION

With classroom, live online or eLearning training, we offer flexible options to help you get knowledge. We conduct over 4,000 customer training courses every year, and we even have our own training centers in 19 countries

MODERNIZATION & IMPROVEMENT

Our modernization program is tailored to your machines and processes. We can evaluate your data and situation and advise you on the next step.

ANALYSIS & SUSTAINABILITY

On request, we analyze all your processes with proven tools and procedures (LeanSixSigma). We have a large, certified team of experts for this purpose.

FINANCING & CONSULTING

We offer you tailor-made financing concepts worldwide. With more than 60 years of experience and a close partner network of prominent banks and insurance companies to help us to find the right solution for you, we're always transparent and reliable in processing.

Fast support:

94% resolution rate
via our hotline

Close to you:

1,350 service experts worldwide

We get things moving:

Over 1,000 worldwide spare parts
shipments each day

No one else has that:

Electronic documentation on over
150,000 machines, available in 28
languages

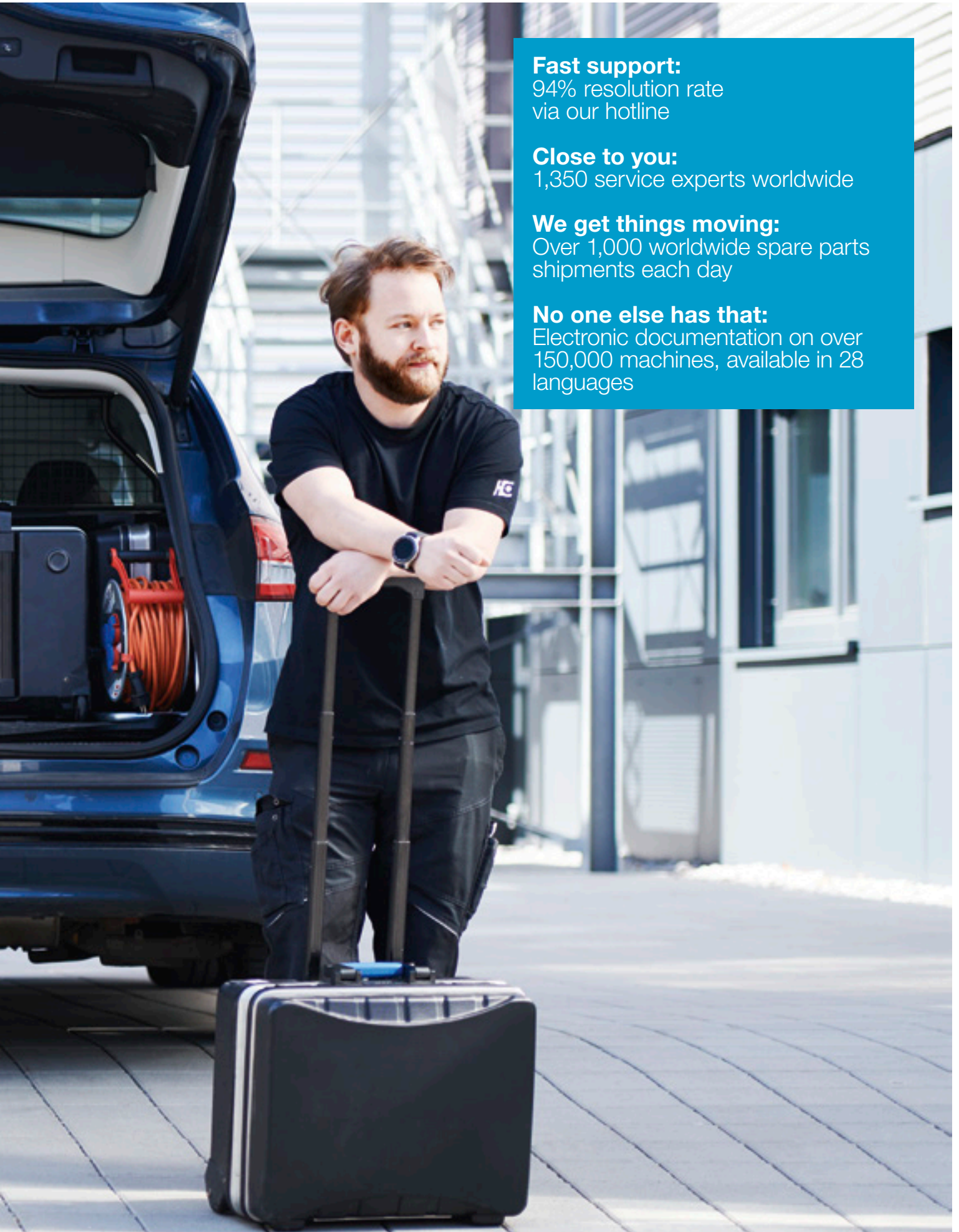



HOMAG Group AG

info@homag.com
www.homag.com

YOUR SOLUTION